



XXXXXXXXXXXX

DATE	DRAWN	CHKD	SCALE	DRAWING NUMBER
23NOV2021	HIX	P.L	1:1	J-0710323

REV	DATE	DRAWN/CHKD	DESCRIPTION	PART NUMBER	MATERIAL	FINISH
				0710323	XXXXX	XXXXX

MILLIMETERS	
TOLERANCES UNLESS OTHERWISE NOTED	
UP TO 20	±0.2
OVER 20 UP TO 50	±0.3
OVER 50 UP TO 100	±0.5
OVER 100 UP TO 200	±0.6
OVER 200 UP TO 300	±0.9
ANGLES	±2°
	THIRD ANGLE PROJECTION
	A4 PAPER SIZE

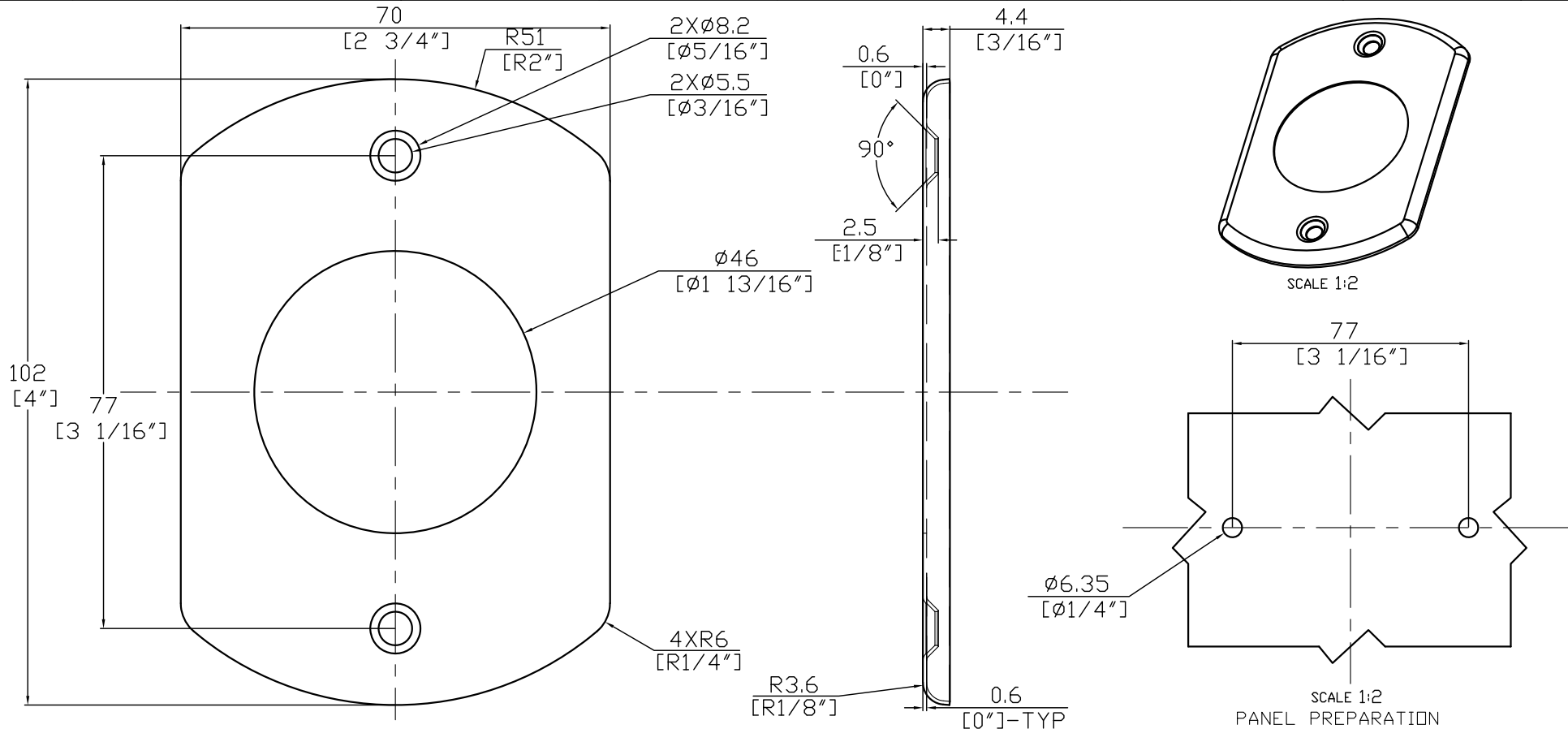

CONFIDENTIALITY NOTICE: The information contained in this document unless otherwise stated is privileged and confidential information and is intended for the use of the individual or company that have been specifically authorized to receive it. If you are not the intended recipient, and or if you are not under a confidentiality agreement with the Marine Town Inc., you are hereby notified that any use of the information herein by you or any dissemination, distribution or copying of this document or its content is strictly prohibited, failure to notify sender to the contrary within ten days constitutes agreement to these terms. If you have received this document in error, please delete it and notify Marine Town immediately at 886-2-2957-9880 or info@marinetown.com.tw.